

# REALTEK

**NOT FOR PUBLIC RELEASE**

## RTL9300

### LED

#### Application Note

Rev. 1.0  
21 Apr 2017



Realtek Semiconductor Corp.  
No. 2, Innovation Road II, Hsinchu Science Park, Hsinchu 300, Taiwan  
Tel.: +886-3-578-0211 Fax: +886-3-577-6047  
[www.realtek.com](http://www.realtek.com)

**COPYRIGHT**

©2015 Realtek Semiconductor Corp. All rights reserved. No part of this document may be reproduced, transmitted, transcribed, stored in a retrieval system, or translated into any language in any form or by any means without the written permission of Realtek Semiconductor Corp.

**TRADEMARKS**

Realtek is a trademark of Realtek Semiconductor Corporation. Other names mentioned in this document are trademarks/registered trademarks of their respective owners.

**DISCLAIMER**

Realtek provides this document “as is”, without warranty of any kind, neither expressed nor implied, including, but not limited to, the particular purpose. Realtek may make improvements and/or changes in this document or in the product described in this document at any time. This document could include technical inaccuracies or typographical errors.

**USING THIS DOCUMENT**

This document is intended for use by the system engineer when integrating with Realtek switch products. Though every effort has been made to assure that this document is current and accurate, more information may have become available subsequent to the production of this guide. In that event, please contact your Realtek representative for additional information that may help in the development process.

Revision	Release Date	Summary
1.0	2017/04/21	Initial

# Contents

<b>1</b>	<b>LED</b>	<b>5</b>
1.1	Overview	5
1.2	LED Modes	5
1.2.1	Serial Mode	6
1.2.2	Scan Mode	9
1.2.3	Register Setting	13
1.2.4	SDK Setting	13
1.3	Power on Blinking	13
1.3.1	Register Setting	14
1.3.2	SDK Setting	15
1.4	System LED	15
1.4.1	Register Setting	16
1.4.2	SDK Setting	16
1.5	Port Status Indication	17
1.5.1	Register Setting	18
1.5.2	SDK Setting	20
1.6	Software LED Control	21
1.6.1	Register Setting	21
1.6.2	SDK Setting	23
1.7	Loading Indication	24
1.7.1	Register Setting	24
1.7.2	SDK Setting	25

## Table List

Table 1-1	LED Pin Description .....	5
Table 1-2	RTL8231 Shift Register Mode Strapping Pins Configuration .....	6
Table 1-3	RTL8231 SMI Mode Strapping Pins Configuration .....	9
Table 1-4	Scan Single Color LED Application Mode .....	9
Table 1-5	LED_GLB_CTRL Register – LED_MODE_SEL.....	13
Table 1-6	LED_GLB_CTRL Register – STEPx_PWR_ON_LED .....	15
Table 1-7	LED_GLB_CTRL Register – PWR_ON_BLINK_SEL.....	15
Table 1-8	System LED Strapping Pin.....	16
Table 1-9	LED_GLB_CTRL Register – SYS_LED_EN .....	16
Table 1-10	LED_GLB_CTRL Register – SYS_LED_MODE .....	16
Table 1-11	LED Definition.....	17
Table 1-12	LED_SETn_0_CTRL Register, n=0~3 .....	18
Table 1-13	LED_SETn_1_CTRL Register, n=0~3 .....	18
Table 1-14	LED_PORT_COPR_SET_SEL_CTRL Register.....	18
Table 1-15	LED_PORT_FIB_SET_SEL_CTRL Register.....	18
Table 1-16	LED_PORT_COPR_MASK_CTRL Register .....	19
Table 1-17	LED_PORT_FIB_MASK_CTRL Register .....	19
Table 1-18	LED_PORT_NUM_CTRL Register .....	19
Table 1-19	LED_PORT_COMBO_MASK_CTRL Register .....	19
Table 1-20	LED_PORT_SW_EN_CTRL Register .....	21
Table 1-21	SW_LED_LOAD Register .....	21
Table 1-22	LED_PORT_SW_CTRL Register.....	22
Table 1-23	Levels of Loading Indication .....	24
Table 1-24	LED_GLB_CTRL Register – LED_LOAD_EN.....	24
Table 1-25	LED_LOAD_LV1_1G Register .....	25
Table 1-26	LED_LOAD_LV2_1G Register .....	25
Table 1-27	LED_LOAD_LV3_1G Register .....	25

## Figure List

Figure 1-1	RTL8231 Shift Register Mode logic Diagram.....	6
Figure 1-2	RTL9300 24G+4*10G Combo Serial LED Connection with RTL8231 Diagram .....	7
Figure 1-5	RTL9300 24G+4*10G Combo Serial LED Connection with 74HC595 Diagram .....	8
Figure 1-6	RTL9300 24G+4G Combo and Per Port 3 Single Color LED Circuit .....	10
Figure 1-7	RTL9300 24G+4G Combo and Per Port 2 Single Color LED Circuit .....	11
Figure 1-8	RTL9300 24G+4*10G Combo in Bi-color Scan Mode.....	12
Figure 1-9	Power on LED Timing Diagram .....	14
Figure 1-10	Power on Blinking Flow Chart.....	14
Figure 1-11	Loading Calculation.....	24

# 1 LED

## 1.1 Overview

RTL9300 provides flexible LED display to show the speed, link status and other information of the port status. RTL9300 supports per port maximum 4 LEDs (optional 3 LEDs, 2 LEDs, 1 LED in serial LED mode, single color scan LED mode) display and 3 LEDs in bi-color scan LED mode display.

The LED function supports following features:

<i>3 LED modes</i>	Serial mode, single color scan mode and bi-color scan mode.
<i>3 steps power on blinking</i>	Could configure power on blinking for LED[3:0] in step1 and step2, and all LEDs are off in step3. Power on blinking time - disable, 400ms, 800ms or 1.6s.
<i>System LED</i>	LED display mode - off, blinking 64ms, blinking 1024ms or light.
<i>Port status indication</i>	Link, active, RX, TX, half/full duplex, collision, 10G/1000M/100M/10M link/active or blinking
<i>Software LED control</i>	Software could control all LEDs status to be off, blinking or light.
<i>5 levels LED loading indication</i>	Could dependent on traffic flow rate to decide LED blinking rate.

## 1.2 LED Modes

RTL9300 supports three LED modes: serial mode, single color scan mode and bi-color scan mode.

RTL9300 provide 2 LED pins to connect with shift register in serial mode or RTL8231 in scan mode. The description of these two pins is listed in Table 1-1.

**Table 1-1 LED Pin Description**

Pin Name	Pin No.	Description
LED_CLK	C1	(1) In Serial LED mode: Reference output clock for serial LED interface and Data is latched on the rising of LED_CLK. (2) In single color scan LED mode and bi-color scan LED mode: Reference output clock for MDC/MDIO interface.
LED_DAT	C2	(1) In Serial LED mode: Serial bit stream of link status information. (2) In single color scan LED mode and bi-color scan LED mode: The data written to LED IC.

## 1.2.1 Serial Mode

The serial LED interface, LED\_CLK and LED\_DAT provide clock and data to enable/disable the external shift registers.

In serial LED mode, RTL9300 uses RTL8231 (shift register mode) to replace 74HC164/74HC595 (8-bits serial-in/parallel-out shift register). When using 74HC595, RTL9300 adds SYNC (GPIO[19]) to reduce steal blinking.

### 1.2.1.1 RTL8231 Application

The RTL8231 shift register mode could reserve the serial data, and output parallel data in order.

There are 36 shift registers in one RTL8231.

The output data sequence is shown in Figure 1-1.

**Figure 1-1 RTL8231 Shift Register Mode logic Diagram**

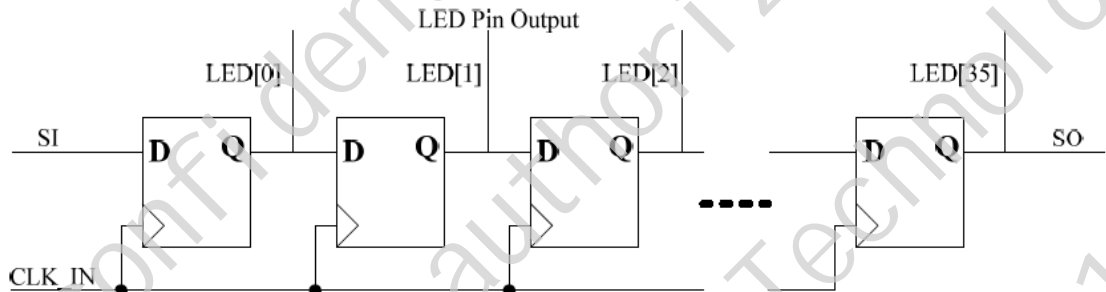

RTL8231 latches the current serial data which received at the SI pin and shift the preceding data to the next stage at the each rising edge of the serial clock.

At the first serial data input, RTL8231 output from pin 15 LED[0]. At the last shift register, the serial data output from LED[35] pin and SO pin at the same time.

Strapping pins configuration of RTL8231 in shift register mode is depicted in Table 1-2.

**Table 1-2 RTL8231 Shift Register Mode Strapping Pins Configuration**

Pin Name	Pin No.	Type	Description	Configuration for serial LED mode
LED[0]/Dis_SMI	15	I/O <sub>PD</sub>	Select RTL8231 in the SMI mode or Shift Register mode. 0: SMI mode.(default) <b>1: Shift register mode.</b>	Pull high
SO/MOD[1]	16	I/O	MOD[1] defines that application circuit is active high or low. 0: Low active 1: High active Note: internal floating. Must be pulled high or low to select the active high or active low application.	Pull low
LED[15]/MOD[0]	42	I/O <sub>PU</sub>	MOD[0] defines the initial value is output high or low. 0: Output low after power on or hardware pin reset. 1: Output high after power on or hardware pin reset. (default)	Pull high

### Circuit design: 24G+4\*10G combo with per-port 4 LEDs

Figure 1-2 is an example of RTL8231 shift register mode for 24G+ 4\*10G Combo with per-port 4 LED, totally 128 LED are used. In this case, four RTL8231 are needed, connect LED\_CLK to both RTL8231 and connect the ahead RTL8231's SO to the next RTL8231's SI so that two RTL8231 can be combined together to form a 144 bits shift register, which is enough for 128 LED application.

**Figure 1-2 RTL9300 24G+4\*10G Combo Serial LED Connection with RTL8231 Diagram**

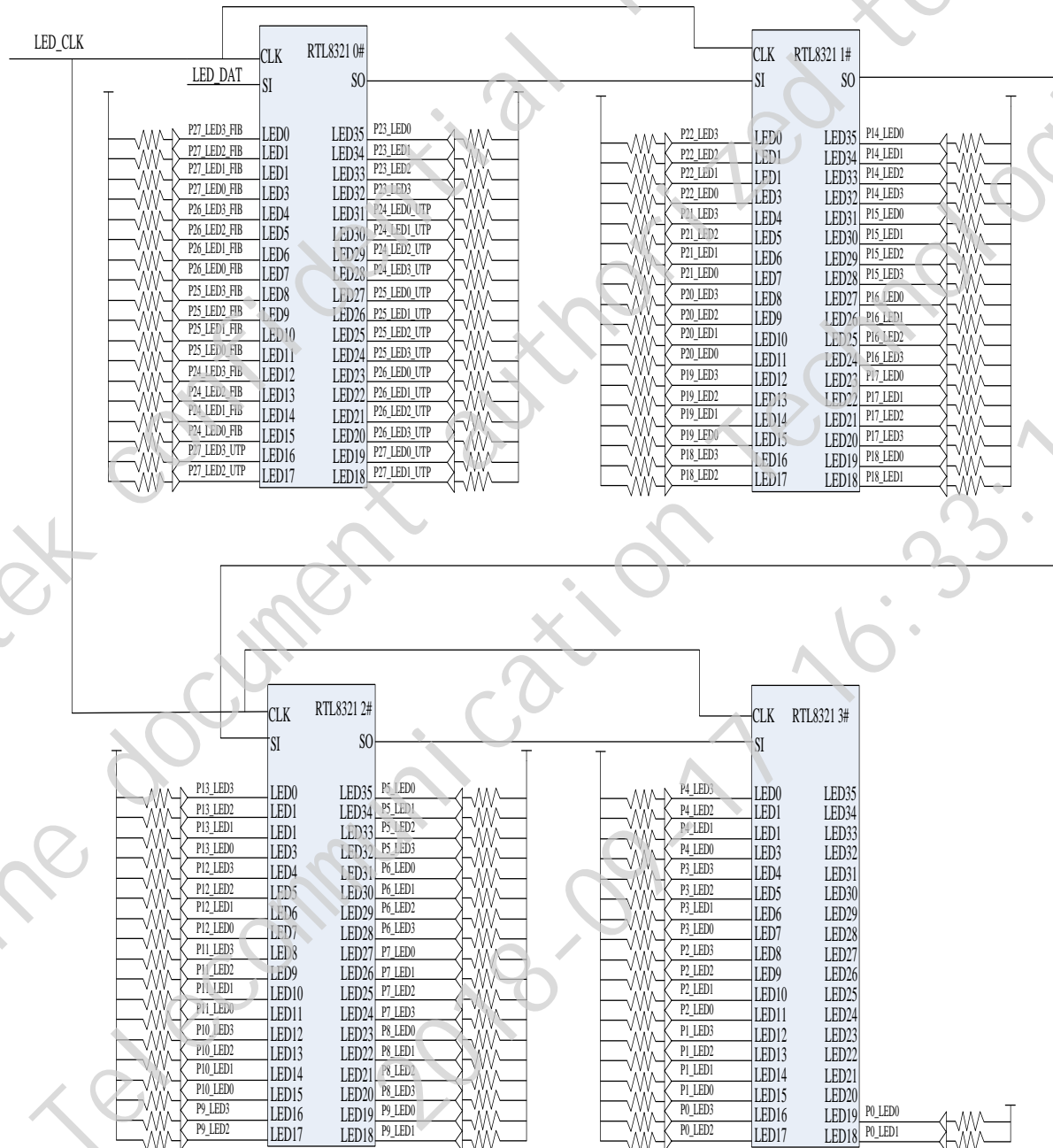





### 1.2.1.2 74HC595 Application

A 74HC595 8–Bit Serial–Input/Serail or Parallel–Output Shift Register with Latched 3–State Outputs captures per-port link status and diagnostic information.

#### Circuit design: 24G+4\*10G combo with per-port 4 LED

The related circuit design for 24G+ 4\*10G Combo mode with per-port 4 LED, as shown in Figure 1-3. In non-combo port mode, those fiber LED and related 74HC595( U1 and U15 in Figure 1-3) can be removed.

Figure 1-3 RTL9300 24G+4\*10G Combo Serial LED Connection with 74HC595 Diagram

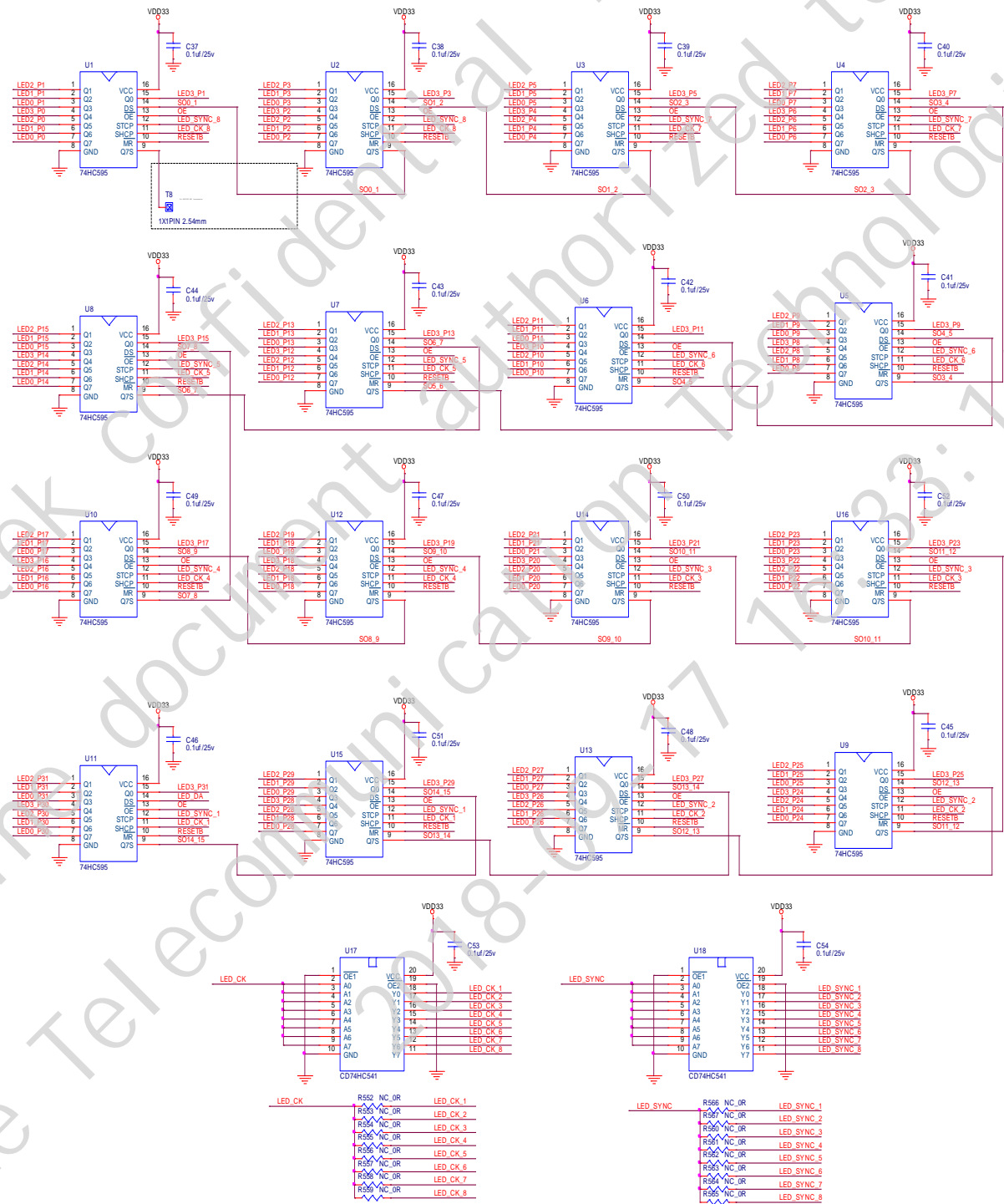

## 1.2.2 Scan Mode

The RTL9300 supports scan LED by connecting with LED IC of the RTL8231, which provides single color and bi-color scan LED.

The *LED\_CLK/LED\_DAT* change to MDC/MDIO interface mode and transmit MDC/MDIO data to LED IC. After power on or hardware reset, RTL9300 initialize the RTL8231, and then write LED status to it to turn on/off LED.

RTL8231 can support at most 72 single color LED in single color mode or 24 bi-color LED plus 24 single color LED in bi-color mode.

In the scan mode, RTL9300 supports at the most 4 single color LEDs or 1 bi-color plus 1 single color LED for each port.

The strapping pins configuration of RTL8231 in SMI Mode is depicted in Table 1-3.

**Table 1-3 RTL8231 SMI Mode Strapping Pins Configuration**

Pin Name	Pin No.	Type	Description	Configuration for serial LED mode
GPIO[35]/Dis_SMI	15	I/O <sub>PD</sub>	Select RTL8231 in the SMI mode or Shift Register mode. <b>0: SMI mode (default)</b> 1: Shift register mode.	Pull low
SCAN_STAB0/Addr[0]	37	I/O <sub>PU</sub>	Addr[4:0] is Device ID. The first LED IC device address should be 0, and others are incrementally addressed;	Pull low
SCAN_STAB1/Addr[1]	38	I/O <sub>PU</sub>		Pull low
SCAN_STAB2/Addr[2]	39	I/O <sub>PU</sub>		Pull low
SCAN_STAB3/Addr[3]	40	I/O <sub>PU</sub>		Pull low
SCAN_STAB4/Addr[4]	41	I/O <sub>PU</sub>		Pull low
SCAN_STAB5/MOD[0]	42	I/O <sub>PU</sub>	When SMI mode is enable, <b>1: MDC/MDIO interface(default)</b> 0: I2C interface	Pull high

### 1.2.2.1 RTL8231 Application – Single Color Scan LED Mode

Table 1-4 is a brief list for some typical application in single color LED mode.

**Table 1-4 Scan Single Color LED Application Mode**

Application Mode	LED_NUM	LED_SEL	LED Copper Port Mask	LED Fiber Port Mask	LED Combo Port Mask	Total LED	RTL8231 Needed
24G+4*10G combo	4 LED	0x3	0x0ffffff	0x0ffffff	0x00ffffff	128	2
24G+4*10G fiber	4 LED	0x3	0x0ffffff	0x0ffffff	0x0ffffff	112	2
	3 LED	0x2	0x0ffffff	0x0ffffff	0x0ffffff	84	2
	2 LED	0x1	0x0ffffff	0x0ffffff	0x0ffffff	56	1
8*10G fiber	4 LED	0x3	0x0f110101	0x0f110101	0x0f110101	32	1
	3 LED	0x2	0x0f110101	0x0f110101	0x0f110101	24	1
	2 LED	0x1	0x0f110101	0x0f110101	0x0f110101	16	1

**Circuit design: 24G+4\*10G combo with per-port 3 single color LED**

Figure 1-4 is an example for single color 24G+4\*10G Combo LED circuit with per port 3 LED

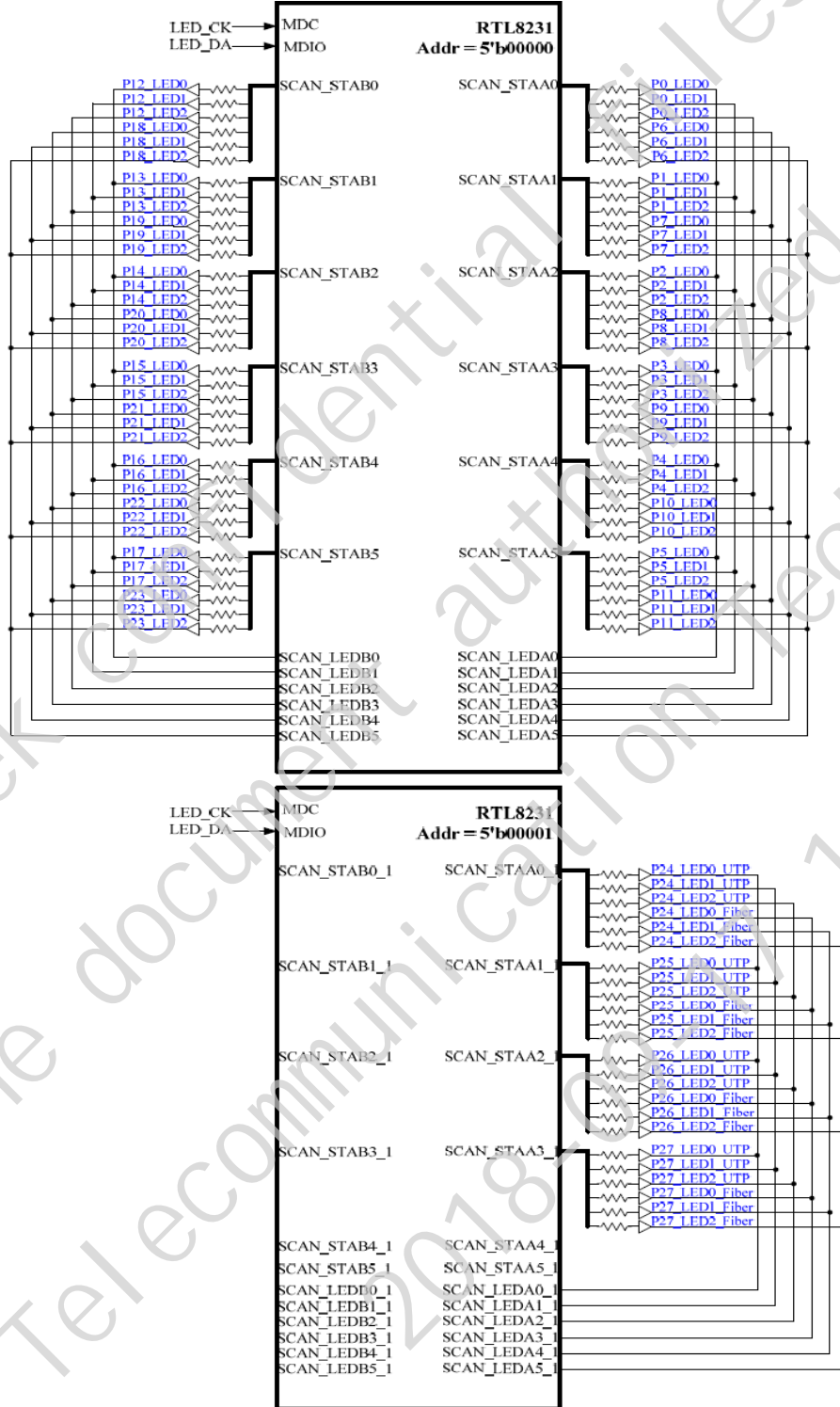
**Figure 1-4 RTL9300 24G+4G Combo and Per Port 3 Single Color LED Circuit**

**Circuit design: 24G+4\*10G combo with per-port 2 single color LED**

Figure 1-5 is an example for single color 24G+4\*10G Combo LED circuit with per port 2 LED

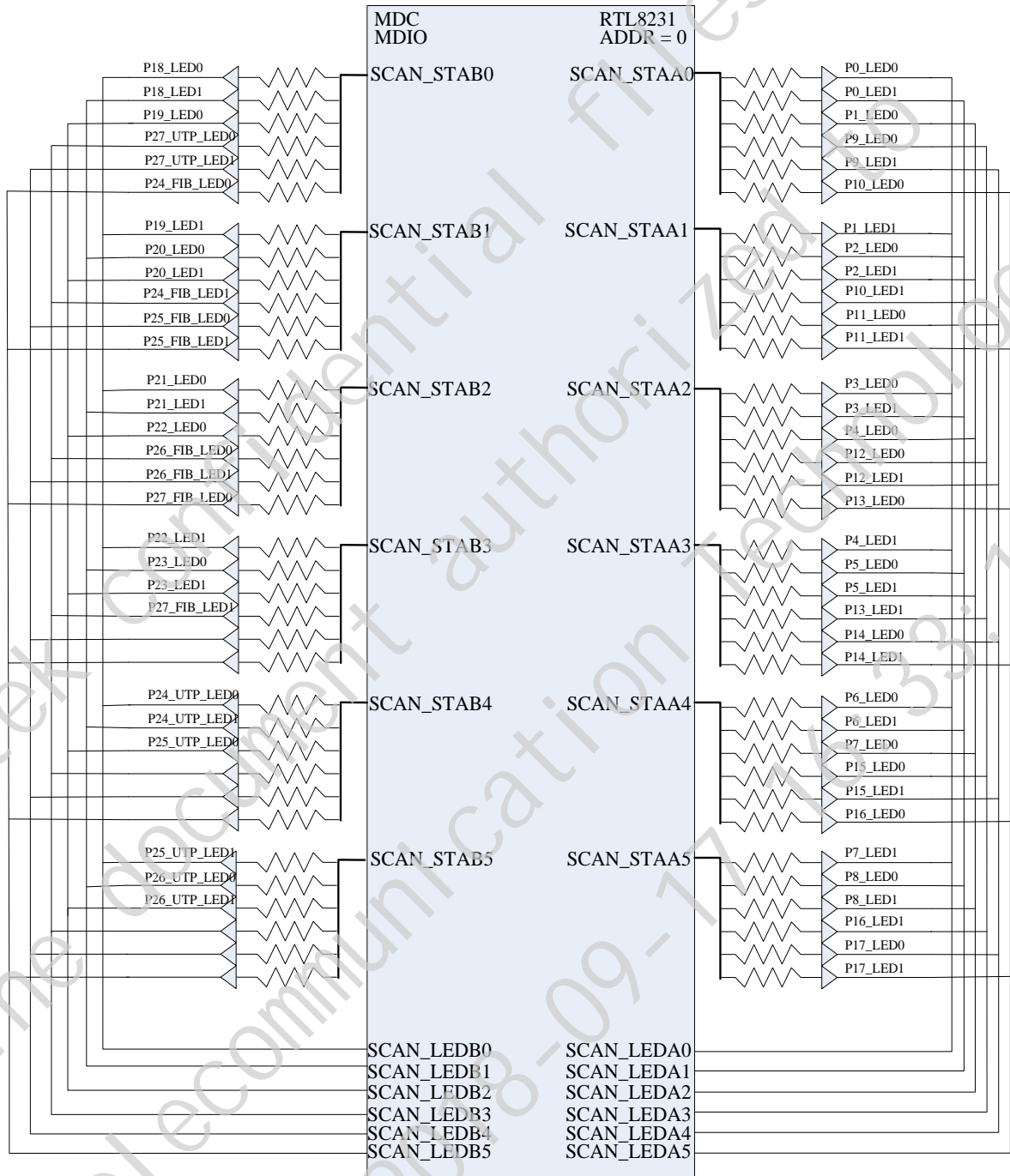
**Figure 1-5 RTL9300 24G+4G Combo and Per Port 2 Single Color LED Circuit**

### 1.2.2.2 RTL8231 Application – Bi-color Scan LED Mode

In bi-color LED mode, a little difference from single color LED is that LED\_NUM\_SEL register must be select 3-LEDs.

**Circuit design: 24G+4\*10G combo with per-port 3 LED**

**Figure 1-6 RTL9300 24G+4\*10G Combo in Bi-color Scan Mode**

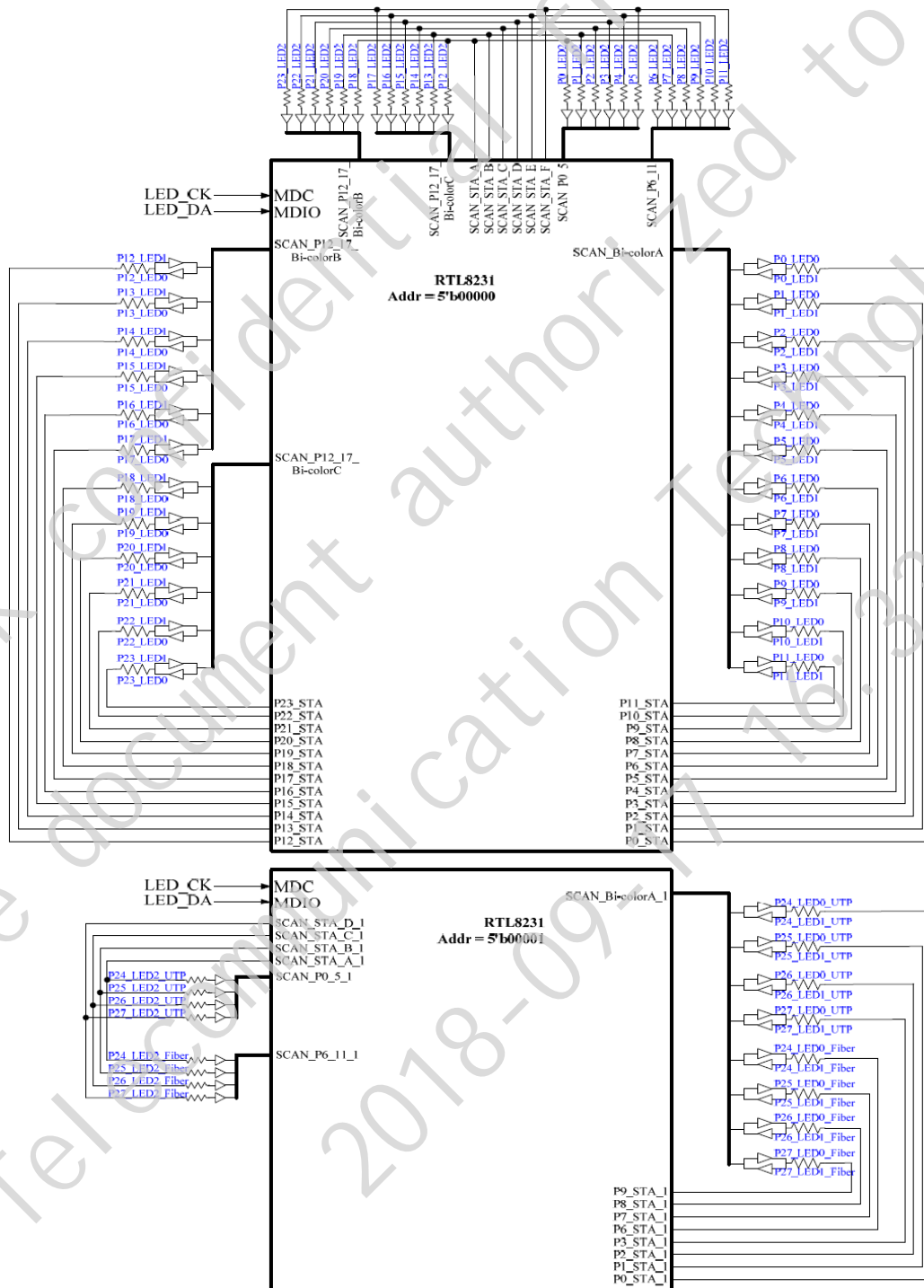



### 1.2.3 Register Setting

LED mode is decided by software.

Table 1-5 LED\_GLB\_CTRL Register – LED\_MODE\_SEL

Bits	Field	Description	Type	Default
1:0	LED_MODE_SEL	LED MODE selection. 0x0: Disable LED. 0x1: Enable LED, and display LED in serial mode; 0x2: Enable LED, and display LED in single color scan mode; 0x3: Enable LED, and display LED in bicolor scan mode;	RW	0x3

### 1.2.4 SDK Setting

#### SDK3

Configure `.led_if_sel` in `sdk\system\include\hwp\hw_profiles\rtlxxx_xxx_demo.c`

```
.led.descp = {
    .led_if_sel = LED_IF_SEL_SERIAL,
```

`.led_if_sel` could be configured as:

- LED\_IF\_SEL\_SERIAL
- LED\_IF\_SEL\_SINGLE\_COLOR\_SCAN
- LED\_IF\_SEL\_BI\_COLOR\_SCAN

#### rtk API

None.

## 1.3 Power on Blinking

RTL9300 supports power on blinking after every power on or reset. In order to support bi-color LED display, three steps are designed.

Table 1-6 is the list of register that control the LED on/off in step1 and step2 control the LED on/off, and in step3 all LED are off

LED on/off time in each step can also be set by register, as listed in Table 1-7.

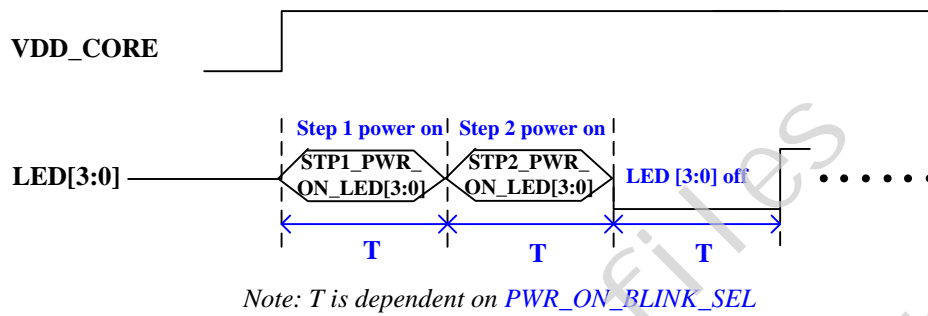
**Figure 1-7 Power on LED Timing Diagram**

LED\_MODE must not be “disable” then LED can start to display. LED\_MODE should be disabled before LED setting is ready that can prevent the LED blinking before software ready.

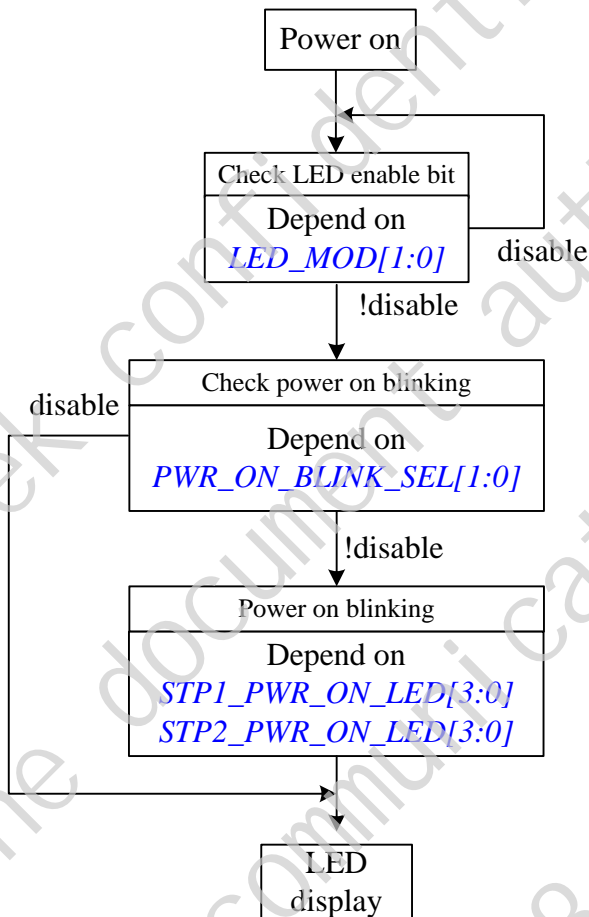
**Figure 1-8 Power on Blinking Flow Chart**

### 1.3.1 Register Setting

Steps of power on blinking are global setting for all ports. A typical setting for bi-color LED mode is that set STEP1\_PWR\_ON\_LED to 3'b101 and set STEP2\_PWR\_ON\_LED to 3'b110 so that LED0 and LED1 can turn on respectively.

**Table 1-6 LED\_GLB\_CTRL Register – STEP<sub>x</sub>\_PWR\_ON\_LED**

Bits	Field	Description	Type	Default
11:8	STEP2_PWR_ON_LED	Select power on blinking LED in step 2 power on duration. "0" is LED off, "1" is LED on	RW	0x6
7:4	STEP1_PWR_ON_LED	Select power on blinking LED in step 1 power on duration. "0" is LED off, "1" is LED on	RW	0x5

LED power on blinking time can be set by register.

**Table 1-7 LED\_GLB\_CTRL Register – PWR\_ON\_BLINK\_SEL**

Bits	Field	Description	Type	Default
3:2	PWR_ON_BLINK_SEL	Select power on blinking time (T), 0x0: disable 0x1: 400ms 0x2: 800ms 0x3: 1.6s	RW	0x2

## 1.3.2 SDK Setting

### SDK3

There is no configuration in SDK. If want to control LED power on blinking, could add setting into `rtl9300_led_config()` in file `sdk/src/hal/mac/led/led_rtl9300.c`.

Example:

```
val = 0x1;
reg_field_write(unit, LONGAN_LED_GLB_CTRLr, Field_Name, &val);
```

**Field\_Name** could be:

*LONGAN\_STP2\_PWR\_ON\_LEDf* For power on blinking LED in step 2

*LONGAN\_STP1\_PWR\_ON\_LEDf* For power on blinking LED in step 2

*LONGAN\_PWR\_ON\_BLINK\_SELf* For power on blinking time

### rtk API

None.

## 1.4 System LED

RTL9300 uses GPIO[0] to do system LED pin. So GPIO[0] can be a GPIO pin or system LED pin depend on `SYS_LED_EN` setting.

System LED must be high activity to prevent abnormal blinking during system power on period.





## 1.4.1 Register Setting

Enable/disable system LED.

Table 1-8 System LED Strapping Pin

Pin Name	Pin No.	Description
SYS_LED_EN	B5	Enable System LED

Table 1-9 LED\_GLB\_CTRL Register – SYS\_LED\_EN

Bits	Field	Description	Type	Default
15:15	SYS_LED_EN	When enable System LED, the GPIO[0] change to system LED pin. Strapping pin. 0b0: Disable system LED 0b1: Enable system LED	RW	0x1



### Note

The default value of SYS\_LED\_EN is enabled. If wants to enable GPIO[0], must disable system LED.

System LED mode configuration.

Table 1-10 LED\_GLB\_CTRL Register – SYS\_LED\_MODE

Bits	Field	Description	Type	Default
14:13	SYS_LED_MODE	System LED mode configuration When SYS_LED_EN=1, The system LED can be configured as following: 0x0: off 0x1: Blinking 64ms 0x2: Blinking 1024ms 0x3: Light	RW	0x1

## 1.4.2 SDK Setting

### SDK3

There is no configuration in SDK. If want to control system LED, could add setting into rtl9300\_led\_config() in file sdk/src/hal/mac/led/led\_rtl9300.c.

### rtk API

```
int32 rtk_led_sysEnable_get(uint32 unit, rtk_led_type_t type, rtk_enable_t *pEnable);
int32 rtk_led_sysEnable_set(uint32 unit, rtk_led_type_t type, rtk_enable_t enable);
int32 rtk_led_sysMode_get(uint32 unit, rtk_led_swCtrl_mode_t *pMode);
```

```
int32 rtk_led_sysMode_set(uint32 unit, rtk_led_swCtrl_mode_t mode);
```

# 1.5 Port Status Indication

In serial mode and single color LED mode, RTL9300 support at most 4 LED per port and each LED status can be defined individually, as listed in Table 1-11.

However, in bi-color LED mode, RTL9300 supports at most 3 LED per port, and LED0 and LED1 can't light simultaneously, so the definition of LED0 and LED1 should avoid this restriction.

RTL9300 supports 4 sets of LED definition setting, as listed in Table 1-12 and Table 1-13. Furthermore, RTL9300 provides 2 registers for LED\_SET selecting, one for copper and the other for fiber, as listed in Table 1-14 and Table 1-15.

**Table 1-11 LED Definition**

SETx_LEDx_SEL		Definition	
Bit[0]	10G	Speed selection. Combine with Link/Link Flash/ACT	
Bit[1]	5G		
Bit[2]	reserved		
Bit[3]	2.5G		
Bit[4]	reserved		
Bit[5]	1G		
Bit[6]	reserved		
Bit[7]	100M		
Bit[8]	10M		
Bit[9]	Link	LED light when link established.	Combine with speed selection.
Bit[10]	Link blink	LED blink when link established.	
Bit[11]	ACT	LED blink when packet transmitting or receiving.	
Bit[12]	RX	LED blink when packet receiving.	There is no relationship with speed selection.
Bit[13]	TX	LED blink when packet transmitting.	
Bit[14]	COL	LED blink when collision occurring.	
Bit[15]	Duplex	LED light when link at full duplex.	

The example of LED definitions:

<i>Link/ACT</i>	SETx_LEDx_SEL = 0x0bff
<i>1000M Link/ACT</i>	SETx_LEDx_SEL = 0x0a20
<i>1000M/100M Link/ACT</i>	SETx_LEDx_SEL = 0x0aa0



RTL9300 supports register *LED\_COPR\_PMASK[27:0]*, *LED\_FIB\_PMASK[27:0]* to decide enable/disable port LED signal stream, as listed in Table 1-16 and Table 1-17.

Per-Port LED number can be selected by register configured, as listed in Table 1-18.

RTL9300 also supports combo port LED to distinguish from UTP port and Fiber port, when the PHY can work either on UTP mode or fiber mode, and *LED\_COMBO\_PMASK[27:0]* decide whether copper/fiber status display on the same LED, as listed in Table 1-19.

## 1.5.1 Register Setting

Configuration for LED indication set0~set3, each set defines LED0~LED3 status.

**Table 1-12 LED\_SETn\_0\_CTRL Register, n=0~3**

Bits	Field	Description	Type	Default
31:16	SET0_LED1_SEL	Select set0 LED1 mode configuration. Default is 1000M Link/Act.	RW	0x0a20
15:0	SET0_LED0_SEL	Select set0 LED0 mode configuration. Default is 10M/100M Link/Act.	RW	0x0b80

**Table 1-13 LED\_SETn\_1\_CTRL Register, n=0~3**

Bits	Field	Description	Type	Default
31:16	SET0_LED3_SEL	Select set0 LED3 mode configuration. Default is Full duplex.	RW	0x8000
15:0	SET0_LED2_SEL	Select set0 LED2 mode configuration. Default is 10G Link/Act.	RW	0x0a01

Configuration for LED indication set of Copper port.

**Table 1-14 LED\_PORT\_COPR\_SET\_SEL\_CTRL Register**

Bits	Field	Description	Type	Default
1:0	LED_COPR_SET_PSEL	Select per port copper LED definition is set0 or set1 or set2 or set3. 0x0: set0 0x1: set1 0x2: set2 0x3: set3	RW	0x0

Select LED indication set for Fiber port.

**Table 1-15 LED\_PORT\_FIB\_SET\_SEL\_CTRL Register**

Bits	Field	Description	Type	Default
------	-------	-------------	------	---------



1:0	LED_FIB_SET_PSEL	Select per port fiber LED definition is set0 or set1 or set2 or set3. 0x0: set0 0x1: set1 0x2: set2 0x3: set3	RW	0x0
-----	------------------	---	----	-----

Configure port mask for Copper LED.

**Table 1-16 LED\_PORT\_COPR\_MASK\_CTRL Register**

Bits	Field	Description	Type	Default
0:0	LED_COPR_PMASK	Copper LED port mask, default value is decided by chip mode.	RW	0x1

Configure port mask for Fiber LED.

**Table 1-17 LED\_PORT\_FIB\_MASK\_CTRL Register**

Bits	Field	Description	Type	Default
0:0	LED_FIB_PMASK	Fiber LED port mask, default value is decided by chip mode	RW	0x1

Select LED number for specified port.

**Table 1-18 LED\_PORT\_NUM\_CTRL Register**

Bits	Field	Description	Type	Default
1:0	LED_NUM_SEL	Select LED number for each port. 0x0: 1 LEDs for each port. Pn_LED[0]. 0x1: 2 LEDs for each port. Pn_LED[1:0]. 0x2: 3 LEDs for each port. Pn_LED[2:0]. 0x3: 4 LEDs for each port. Pn_LED[2:0]. Note: This register must be select 3-LEDs in Bi-color scan LED mode.	RW	0x0

Configure port mask for combo port.

**Table 1-19 LED\_PORT\_COMBO\_MASK\_CTRL Register**

Bits	Field	Description	Type	Default
0:0	LED_COMBO_PMASK	LED combo port selection. Mapping to physical port 27 ~ port 0. 0b0: Copper status display on copper LED, fiber status display on fiber LED. 0b1: Copper and fiber status display on same LED. default value is decide by chip mode	RW	0x1

## 1.5.2 SDK Setting

### SDK3

In sdk\system\include\hwp\hw\_profiles\rtlxxx\_xxx\_demo.c

Refer to Table 1-11 LED Definition to modify setting. led\_definition\_set[0].led[x] is for SET0\_LEDx\_SEL, you can add led\_definition\_set[1].led[x] for SET1\_LEDx\_SEL.

```
.led.descp = {
.led_if_sel = LED_IF_SEL_SERIAL,
.led_definition_set[0].led[0] = 0xB80,      /* 10/100Mbps link/act */
.led_definition_set[0].led[1] = 0xA20,      /* 1000Mbps link/act */
.led_definition_set[0].led[2] = 0xA01,      /* duplex mode */
.led_definition_set[0].led[3] = 0x0,        /* Not blink */
.led_definition_set[0].led[4] = HWP_LED_END, /* None */
```

In sdk\system\include\hwp\hw\_profiles\rtlxxx\_xxx\_demo.c

led\_c is for LED\_COPR\_SET\_PSEL. (0 means select SET0\_LEDx\_SEL)

led\_f is for LED\_FIB\_SET\_PSEL

```
.port.descp = {
{ ...
.led_c = 0, .led_f = 0, ... },
```

In sdk\system\hwp\hw\_init.c, hwp\_init\_led().

SDK calculates LED number via led\_definition\_set[x].led[x] defined in hw\_profile.

Then check the set that led\_c and led.f defined in per port to configure LED number of port.

```
.led.descp = {
.led_if_sel = LED_IF_SEL_SERIAL,
.led_definition_set[0].led[0] = 0xB80,
.led_definition_set[0].led[1] = 0xA20,
.led_definition_set[0].led[2] = 0xA01,
.led_definition_set[0].led[3] = 0x0,
.led_definition_set[0].led[4] = HWP_LED_END,      → LED number of set0 is 4
.led_definition_set[1].led[0] = 0xB80,
.led_definition_set[1].led[1] = 0xA20,
.led_definition_set[1].led[2] = 0xA01,
.led_definition_set[1].led[3] = HWP_LED_END,      → LED number of set1 is 3
```

In sdk\system\include\hwp\hw\_profiles\rtlxxx\_xxx\_demo.c

```
If (led.layout != HWP_NONE)
```

```
{
```

```
Set related bit of LED_COPR_PMASK and LED_FIB_PMASK as 1.
```

```
If (led.layout = DOUBLE_SET)
```

```
{
```

```
Set related bit of LED_COMBO_PMASK = 0. /* DOUBLE_SET*/
```

```
}
```

```
else
```

```

{
    Set related bit of LED_COMBO_PMASK = 1. /*SINGLE_SET*/
}
}

```

```

.port.descp = {
    { ... .led_layout = SINGLE_SET,},

```

### rtk API

None.

## 1.6 Software LED Control

Software can control all of LEDs in all LED modes.

Before software control LED, it must set SW\_CTRL\_LED\_EN=1.

For all LEDs synchronization issue, after software configured all Software Control LED Registers and then set SW\_LED\_LOAD=1 to notify ASIC to update all of LEDs state.

### 1.6.1 Register Setting

Enable software LED control for each LED of port. Each bit stands for one LED, bit0 for LED0, bit1 for LED1 ..., set 1 to enable.

**Table 1-20 LED\_PORT\_SW\_EN\_CTRL Register**

Bits	Field	Description	Type	Default
3:0	SW_CTRL_LED_EN	Enable software control LED3-LED0 0x0: LED3-LED0 Disable 0x1: LED3-LED1 disable, LED0 Enable 0x2: LED3-LED2 and LED0 disable, LED1 enable ... 0xF: LED3-LED0 enable	RW	0x0

After software configured all Software Control LED Registers and then set SW\_LED\_LOAD=1 to notify ASIC to update all of LEDs state.

**Table 1-21 SW\_LED\_LOAD Register**

Bits	Field	Description	Type	Default
0:0	SW_LED_LOAD	In software control LED mode, since software LED control registers distribute in different register sets, they need one bit for all software control registers synchronization. 0b0: normal 0b1: load all software control LED registers. Self-clear to "0".	RWA C	0x0



Define LED mode for Copper/Fiber LED0~LED3.

**Table 1-22 LED\_PORT\_SW\_CTRL Register**

Bits	Field	Description	Type	Default
31:24	RESERVED			
23:21	SW_FIB_LED3_MODE	Fiber LED3 mode configuration for port. When SW_CTRL_LED_EN=1, The LED3 of port can be configured as following: 0x0: off 0x1: Blinking 32ms 0x2: Blinking 64ms 0x3: Blinking 128ms 0x4: Blinking 256ms 0x5: Blinking 512ms 0x6: Blinking 1024ms 0x7: Light	RW	0x0
20:18	SW_FIB_LED2_MODE	Fiber LED2 mode configuration for port. When SW_CTRL_LED_EN=1, The LED2 of port can be configured as following: 0x0: off 0x1: Blinking 32ms 0x2: Blinking 64ms 0x3: Blinking 128ms 0x4: Blinking 256ms 0x5: Blinking 512ms 0x6: Blinking 1024ms 0x7: Light	RW	0x0
17:15	SW_FIB_LED1_MODE	Fiber LED1 mode configuration for port. When SW_CTRL_LED_EN=1, The LED1 of port can be configured as following: 0x0: off 0x1: Blinking 32ms 0x2: Blinking 64ms 0x3: Blinking 128ms 0x4: Blinking 256ms 0x5: Blinking 512ms 0x6: Blinking 1024ms 0x7: Light	RW	0x0
14:12	SW_FIB_LED0_MODE	Fiber LED0 mode configuration for port. When SW_CTRL_LED_EN=1, The LED0 of port can be configured as following: 0x0: off 0x1: Blinking 32ms 0x2: Blinking 64ms 0x3: Blinking 128ms 0x4: Blinking 256ms 0x5: Blinking 512ms 0x6: Blinking 1024ms 0x7: Light	RW	0x0



11:9	SW_COPR_LED3_MODE	Copper LED3 mode configuration for port. When SW_CTRL_LED_EN=1, The LED3 of port can be configured as following: 0x0: off 0x1: Blinking 32ms 0x2: Blinking 64ms 0x3: Blinking 128ms 0x4: Blinking 256ms 0x5: Blinking 512ms 0x6: Blinking 1024ms 0x7: Light	RW	0x0
8:6	SW_COPR_LED2_MODE	Copper LED2 mode configuration for port. When SW_CTRL_LED_EN=1, The LED2 of port can be configured as following: 0x0: off 0x1: Blinking 32ms 0x2: Blinking 64ms 0x3: Blinking 128ms 0x4: Blinking 256ms 0x5: Blinking 512ms 0x6: Blinking 1024ms 0x7: Light	RW	0x0
5:3	SW_COPR_LED1_MODE	Copper LED1 mode configuration for port. When SW_CTRL_LED_EN=1, The LED1 of port can be configured as following: 0x0: off 0x1: Blinking 32ms 0x2: Blinking 64ms 0x3: Blinking 128ms 0x4: Blinking 256ms 0x5: Blinking 512ms 0x6: Blinking 1024ms 0x7: Light	RW	0x0
2:0	SW_COPR_LED0_MODE	Copper LED0 mode configuration for port. When SW_CTRL_LED_EN=1, The LED0 of port can be configured as following: 0x0: off 0x1: Blinking 32ms 0x2: Blinking 64ms 0x3: Blinking 128ms 0x4: Blinking 256ms 0x5: Blinking 512ms 0x6: Blinking 1024ms 0x7: Light	RW	0x0

## 1.6.2 SDK Setting

### SDK3

There is no configuration in SDK. Call rtk APIs by application to control LED.  
Could implement as following steps:

1. Enable software LED control for specified LED  
rtk\_led\_portLedEntitySwCtrlEnable\_set()
2. Set LED mode for specified LED  
rtk\_led\_portLedEntitySwCtrlMode\_set()





3. Load LED setting  
rtk\_led\_swCtrl\_start()

**rtk API**

```
int32 rtk_led_portLedEntitySwCtrlEnable_get(uint32 unit, rtk_port_t port, uint32 entity, rtk_enable_t *pEnable);
```

```
int32 rtk_led_portLedEntitySwCtrlEnable_set(uint32 unit, rtk_port_t port, uint32 entity, rtk_enable_t enable);
```

```
int32 rtk_led_portLedEntitySwCtrlMode_get( uint32 unit, rtk_port_t port, uint32 entity, rtk_port_media_t media, rtk_led_swCtrl_mode_t *pMode);
```

```
int32 rtk_led_portLedEntitySwCtrlMode_set(uint32 unit, rtk_port_t port, uint32 entity, rtk_port_media_t media, rtk_led_swCtrl_mode_t mode);
```

```
int32 rtk_led_swCtrl_start(uint32 unit);
```

# 1.7 Loading Indication

Per port can dependent on traffic flow rate to decide LED blinking rate.

Each kind of speed (10M, 100M, 1000M, 2.5G, 5G, 10G) has 3 thresholds to divide traffic flow to five levels.

**Table 1-23 Levels of Loading Indication**

	Level 0	Level 1	Level 2	Level 3	Level 4
<b>Loading</b>	0%	0%~10%	10%~25%	25%~50%	50%~100%
<b>Blinking time</b>	No blinking	512ms	256ms	64ms	32ms

Per port has one loading counter that counted during every period. Compared the loading counter with threshold value (LEVEL1\_TH, LEVEL2\_TH, LEVEL3\_TH) every 1024ms to decide the traffic flow level and then resets loading counters.

**Figure 1-9 Loading Calculation**

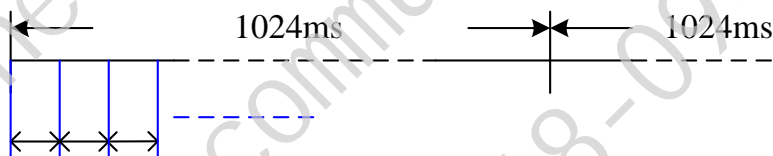

## 1.7.1 Register Setting

**Table 1-24 LED\_GLB\_CTRL Register – LED\_LOAD\_EN**

Bits	Field	Description	Type	Default
------	-------	-------------	------	---------



15:15	LED_LOAD_EN	Enable LED loading indication. 0b0: Disable 0b1: Enable Note: When LED mode configuration is TX(0b00100) or RX(0b00011), the LED_LOAD_EN is not available.	RW	0x0
-------	-------------	--	----	-----

**Table 1-25 LED\_LOAD\_LV1\_1G Register**

Bits	Field	Description	Type	Default
31:20	RESERVED			
19:0	LV1_THR_1G	Loading threshold of level 1 of 1G bps. default threshold value = 1024000 x 10% = 102400 (19000H)	RW	0x19000

**Table 1-26 LED\_LOAD\_LV2\_1G Register**

Bits	Field	Description	Type	Default
31:20	RESERVED			
19:0	LV2_THR_1G	Loading threshold of level 2 of 1G bps. default threshold value = 1024000 x 25% = 256000 (3E800H)	RW	0x3E800

**Table 1-27 LED\_LOAD\_LV3\_1G Register**

Bits	Field	Description	Type	Default
31:20	RESERVED			
19:0	LV3_THR_1G	Loading threshold of level 3 of 1G bps. default threshold value = 1024000 x 50% = 512000 (7D000H)	RW	0x7D000

## 1.7.2 SDK Setting

### SDK3

There is no configuration in SDK. If want to configure LED loading indication, could add setting into `rtl9300_led_config()` in file `sdk/src/hal/mac/led/led_rtl9300.c`.

### rtk API

None.